

Accuphase

E-303

130W/ch. INTEGRATED STEREO AMPLIFIER



The Accuphase E-303 is a integrated stereo amplifier that is ideal for those audio enthusiasts and music lovers who have felt that "while they always desired highest quality reproduction, separate amplifiers seemed too complicated and required too much space"

The E-303 is ideal because it incorporates all the capabilities of separate amplifiers in one single unit, and is one of the most powerful integrated amplifiers today. Power output is 130 watts per channel (20 to 20,000 Hz into 8 ohms) with distortion less than 0.02%.

It also has a built-in Head Amplifier to which low-output, high quality Moving-coil cartridges can be directly connected.

The extravagant circuitry consists of Accuphase's "original" Complementary-Symmetry Push-Pull driven amplifier circuits in every stage, which have effectively reduced harmful Transient Intermodulation Distortion (TIM).

One of the main features is the use of MOS FET (Metal-Oxide Semiconductor FET) devices in a parallel push-pull power output stage. MOS FET is a new, ideal power amplification device. It has given birth to an amplifier which approaches the class-A operation ideal of amp designers much closer than was ever possible before with bipolar transistors.

DC amplifier units are used throughout which have eliminated the need for large capacity capacitors in the Negative Feedback loop. This has reduced sound coloration to a minimum. The high-level amplifier section which contains the tone control circuit is a servo controlled DC AMP. It permits the circuit to operate as a DC amplifier, even when the tone control is on, so there is no noise when the tone control is switched on or off.

This amplifier also features ICL design. All unit amps require no input capacitors and the elimination of a large capacity input capacitor at the head amplifier has contributed greatly to sound quality improvement.

Enjoy the glorious world of music with the E-303 which is the result of our many years of amplifier design experience, and our most recent objective to produce an outstanding integrated amplifier with the same high quality performance of high quality separate amplifiers.

1 130W/CHANNEL REALIZED WITH MOS FETs

"What is the ideal power output device?"

This question has long been a subject of debate, but ever since the potentialities of the MOS FET were revealed at the Audio Engineering Society (U.S.A.), in May, 1976, it became apparent, without question, that this active device held the most promise for the future. However, the birth of high power MOS FETs took a long time due to technical production difficulties. It was finally realized here in Japan ahead of the world. As a result, audio amplifier performance will most likely enter a new era.

The E-303 is the first integrated amplifier which employs these powerful MOS FETs. Four of them are used in a parallel push-pull output stage, and account for the high output power of 130 watts per channel.

Since the MOS FET has characteristics which make it easier to use than bipolar transistors or V-FETs, and also because there is no notching distortion during high frequency transmission, there is a

significant improvement in treble response. Moreover, its high frequency characteristics are excellent and effectively confines harmful TIM to a minimum.

It does not create notching distortion because of its extremely high input impedance, and also because it is voltage controlled, and requires very little power from the previous stage. This makes it possible and easier to utilize a class-A driver amplifier stage with the result that superior characteristics, closer to the ideal class-A operation, can be realized than with bipolar transistors.

Moreover, the MOS FET has a very high gain equivalent to two or three stages of directly coupled Darlington Pair amplifier circuits using bipolar transistors. This permits reducing the number of stages and presents the advantage of superior performance.

Figure 1 shows the power amplifier section of the E-303. Only one Darlington Pair high gain stage is employed between the input differential amp stage and parallel push-pull output. The signal path is very clear cut. The transistors that drive the MOS FETs are employed in a Complementary-Symmetry class-A application and need only to ensure low output impedance of the driver stage.

The bipolar transistor may seem to be full of faults from the above explanation, but it was presented only as a matter of comparison. Nevertheless, a high perfection amplifier can be made even with bipolar transistors when it is well-designed.

2 EVERY STAGE IS COMPLEMENTARY-SYMMETRY PUSH-PULL AMPLIFIER

Every stage from the Head Amplifier input to the MOS FET output is a complementary-symmetry push-pull amplifier circuit. Although it uses almost twice the number of components compared to ordinary circuits, its inherent characteristics, without negative feedback application, and especially its linearity are very superior. Thus, it is a big advantage that it requires only a small amount of negative feedback to maintain the distortion low.

TIM which is harmful to sound quality, is one type of distortion which has been effectively reduced because of this circuit. We have focused our attention on the many advantages of the complementary-symmetry push-pull circuit, and have adopted it completely in all our amplifiers from the very first P-300 and C-200. This circuit (which is increasingly gaining favor) can well be called an Accuphase "original."

3 DC UNIT AMPS

All unit amps are DC types and DC amplifier design was adopted throughout. Large capacity, direct current blocking capacitors in the NF loops were removed and sound coloration was eliminated.

This required complete control of DC drift which was generally recognized as being very difficult in the high-level amplifier section that contains tone control elements, and where its switches and volume control change the values of NF elements.

However, new Servo Control method which completely prevents DC drift was developed and adopted. It allows DC amplifier operation even when the tone control circuit is on.

The Servo Control method is shown in Figure 2. DC drift detected

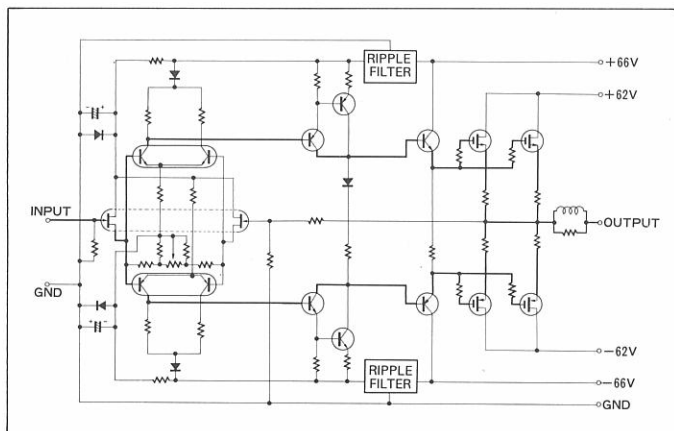

(FIG. 1) MOS FETs' SYMMETRICAL PUSH-PULL POWER AMP.

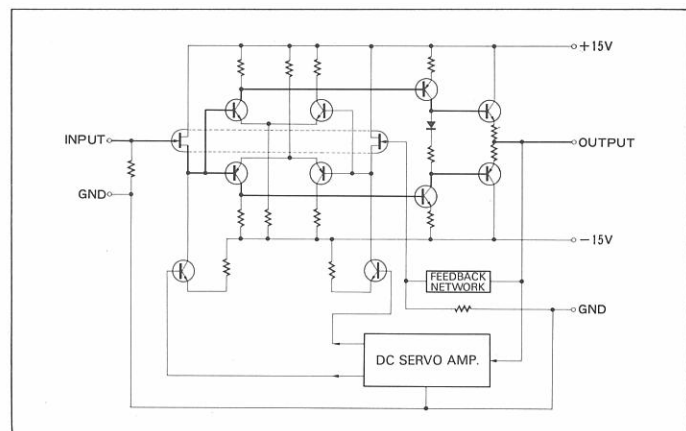

(FIG. 2) SERVO CONTROLLED HIGH-LEVEL AMP.

Accuphase E-303

INTEGRATED STEREO AMPLIFIER

at the output is passed through the servo amplifier and this is used to control the voltage appears at the Source pole of FETs incorporated in the input buffer amplifier. As a result the DC drift of the preamplifier output has been confined to the very low level of $\pm 1\text{mV}$ from -10 to $+80$ degrees centigrade.

Servo Control has also helped to reduce the impedance of the feedback loop, to improve S/N ratio, and to remove the need for 4-gang variable resistors at two places to control volume level.

4 ICL (Input Capacitor-Less) DESIGN

In order to reduce further the tonal coloration effects of capacitors, the input capacitors of unit amplifiers were also eliminated. As a result, there is only one capacitor used in the signal path circuit all the way from AUX and TUNER inputs to the final output.

5 LOW NOISE, WIDE DYNAMIC RANGE HEAD AMPLIFIER

The input circuit of the Head Amplifier employs ultra-low-noise transistors in a differential amp circuit, which together with the low impedance of the NF loop are the reasons for the high S/N ratio of 73 (at rated input). Any type Moving-coil cartridge can be connected directly without fear of clipping distortion because of the wide dynamic range of the Head Amplifier (maximum input voltage 15mV rms). It can also readily accommodate two tone arms with its DISC 1 and DISC 2 inputs which can easily be switch selected.

6 HIGH S/N EQUALIZER AMP

Low noise active devices must be used in the equalizer input circuit to achieve high S/N ratio, but this alone is insufficient. Low noise parts and elements must be used as well. Low impedance of the feedback loop is also most important to obtain low current-noise and thermal-noise.

Class-A operation with large current flow in the final equalizer transistors has lowered the impedance of the NF loop, and greatly reduced the noise generated at the differential input circuit. The S/N ratio is 86dB (at rated input) which is close to the theoretical limit.

7 HIGH PERFORMANCE POWER TRANSFORMER WITH C-I CORE

A high efficiency, low flux leakage, C-I shaped core type power transformer is used for the first time in an audio amplifier. It is the same type as those AC power line transformers on electric posts which readily meet the widely changing load requirements for electricity homes.

Dual, balanced type windings account for the low flux leakage, high efficiency and good regulation of this superior type transformer. Another advantage is that less wire is required for the same number of turns, and means smaller size and lighter weight.

8 TURNOVER SELECTOR SWITCH

A turnover selector switch is provided to expand the tone control function. This provides selection of 200 Hz and 500 Hz turnover frequencies for BASS, and 2 kHz and 7 kHz for TREBLE. The turnover selections of 200 Hz and 7 kHz are especially effective for smooth control over the widest range from the deepest bass to the highest treble tones. Furthermore, a 10-step rotary switch permits accurate 10-step tonal variations, as well as on/off switching of the tone control circuit.

9 THREE-STEP LOUDNESS COMPENSATION

Three-Step Loudness Compensator switch provides a choice of three sound energy balancing curves to make up for the deficiency of the human ear to detect certain audio frequencies during low-level reproduction. This switch also helps to balance out listening room characteristics. COMP 1 provides compensation of +6 dB at 50 Hz; COMP 2: +9dB at 50Hz, and COMP 3: +10dB at 50Hz and also +4dB at 15 kHz. (above values with volume control at -30dB).

10 SUBSONIC FILTER

The provision of filters was based on practicality, and only a 17 Hz 12dB/oct subsonic filter is made available. It is an active filter that was designed to cut off frequencies below 17 Hz that sometimes might cause intermodulation distortion in the audible frequency range.

11 POWER METER DIRECTLY INDICATES OUTPUT IN WATTS

The power meter permits direct reading of output power by logarithmic peak indications. It has a blue and yellow, two-tone indicator scale that brightens up the front panel.

12 OTHER FUNCTIONS

This amplifier is equipped with many other useful functions such as a -20dB Attenuator Switch which is convenient to start off records, a Disc Input Impedance Selector Switch, a Switch to cut off the recording output connection of tape recorders to prevent distortion, and a Switch that permits separation of the preamp and the power amplifier.

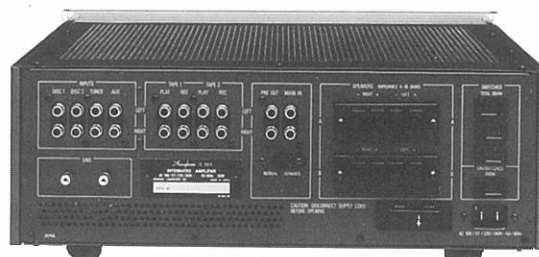

REAR PANEL VIEW

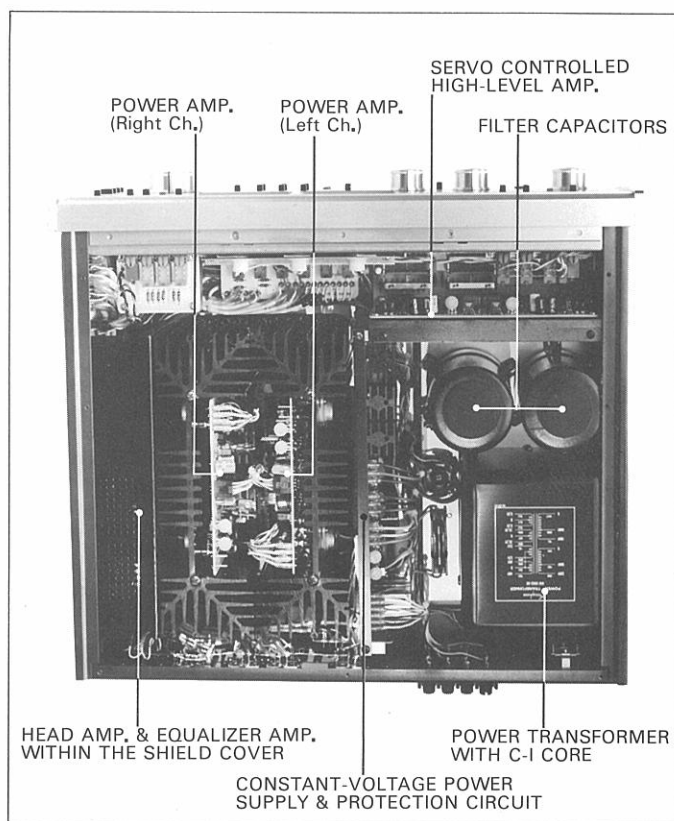

POWER AMP. (Right Ch.) POWER AMP. (Left Ch.) SERVO CONTROLLED HIGH-LEVEL AMP.
 FILTER CAPACITORS
 HEAD AMP. & EQUALIZER AMP. WITHIN THE SHIELD COVER POWER TRANSFORMER WITH C-I CORE
 CONSTANT-VOLTAGE POWER SUPPLY & PROTECTION CIRCUIT

Accuphase E-303

INTEGRATED STEREO AMPLIFIER

GUARANTY SPECIFICATIONS

PERFORMANCE GUARANTY:

All Accuphase product specifications are guaranteed as stated.

POWER OUTPUT: both channels driven from 20Hz to 20,000Hz with no more than 0.02% total harmonic distortion:
 180 watts per channel, min. RMS, at 4 ohms
 130 watts per channel, min. RMS, at 8 ohms
 65 watts per channel, min. RMS, at 16 ohms

TOTAL HARMONIC DISTORTION: from 20Hz to 20,000Hz at any power output from 1/4 watt to rated power:
 0.08% max., at 4 ohms
 0.08% max., at 8 ohms
 0.08% max., at 16 ohms

INTERMODULATION DISTORTION: will not exceed 0.02% at rated power output for any combination of frequencies between 20Hz and 20,000Hz at 8 ohms

FREQUENCY RESPONSE:

Main Amp Input: 20Hz to 20,000Hz; +0, -0.2dB at rated power output
 4Hz to 150,000Hz; +0, -3.0dB at 1 watt power output
 High-Level Input: 20Hz to 20,000Hz; +0, -0.2dB at rated power output
 Low-Level Input: 20Hz to 20,000Hz; +0.2, -0.2dB at rated power output

DAMPING FACTOR: 80, 8 ohms load at 40Hz

INPUT SENSITIVITY AND IMPEDANCE:

DISC 1 (HEAD AMP switch set to OFF); 2.5mV
 Selector for 100-ohm, 47k-ohm, 82k-ohm, 150k-ohm
 DISC 1 (HEAD AMP switch set to ON); 0.125mV, 100-ohm
 DISC 2 (HEAD AMP switch set to OFF); 2.5mV, 47k-ohm
 DISC 2 (HEAD AMP switch set to ON); 0.125mV, 100-ohm
 TUNER/AUX/TAPE PLAY: 160mV, 47k-ohm
 MAIN AMP INPUT: 1.3V, 47k-ohm

MAXIMUM INPUT FOR DISC INPUT: (0.005% THD)

DISC 1, 2 (without HEAD AMP); 300mV RMS at 1kHz
 DISC 1, 2 (with HEAD AMP); 15mV RMS at 1kHz

OUTPUT LEVEL AND IMPEDANCE:

PREAMP. OUTPUT; 1.3V at rated input level, 200 ohms
 TAPE REC. 1, 2; 160mV at rated input level, 200 ohms

HEADPHONE JACK:

for listening with low impedance (4 - 32 ohms) dynamic stereo headphones

VOLTAGE AMPLIFICATION IN DECIBELS:

MAIN AMP INPUT to OUTPUT; 27.8dB
 HIGH-LEVEL INPUT to PREAMP OUTPUT; 18.4dB
 DISC INPUT to TAPE REC. (without HEAD AMP); 36dB
 DISC INPUT to TAPE REC. (with HEAD AMP); 62dB

HUM AND NOISE:

MAIN AMP INPUT; 115dB below rated output, with IHF-A weighted
 HIGH-LEVEL INPUT; 100dB below rated output, with IHF-A weighted
 LOW-LEVEL INPUT (without HEAD AMP); 86dB below rated output, with IHF-A weighted
 LOW-LEVEL INPUT (with HEAD AMP); 72dB below rated output, with IHF-A weighted

TOPE CONTROLS:

10-step Rotary Switch for both channels with turnover frequency switches and ON/OFF switch.
 Tone is varied in 2dB steps. Bass; Turnover frequency 200Hz; ±10dB at 50Hz
 Turnover frequency 500Hz; ±10dB at 100Hz
 Treble; Turnover frequency 2,000Hz; ±10dB at 10kHz
 Turnover frequency 7,000Hz; ±10dB at 50kHz

LOUDNESS COMPENSATOR: (Volume attenuation at -30dB)

COMP 1; +6dB at 50Hz
 COMP 2; +9dB at 50Hz
 COMP 3; +10dB at 50Hz, +4dB at 15kHz

SUBSONIC FILTER: 17Hz cutoff 12dB/oct.

ATTENUATOR: -20dB

POWER LEVEL METER: Peak Level Indication, calibrated to read 0 dB when amplifier produces 130 watts into 8 ohms load

OUTPUT LOAD IMPEDANCE: 4 to 16 ohms

SEMICONDUCTOR COMPLEMENT: 113 Tr's, 2 IC's, 18 FET's, 39 Di's

POWER REQUIREMENT: Voltage selector for 100, 117, 220, 240V 50/60Hz operation
 Consumption: 100 watts at zero signal output
 490 watts at rated power output into 8 ohms load

DIMENSIONS: 445mm(17-1/2 inches) wide, 160mm(6-5/16 inches) max. high
 370mm(14-9/16 inches) deep

WEIGHT: 20 kgs. (44 lbs.) net, 24 kgs. (52.8 lbs.) in shipping carton

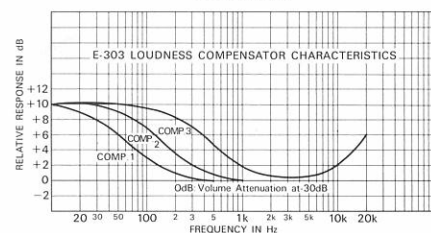
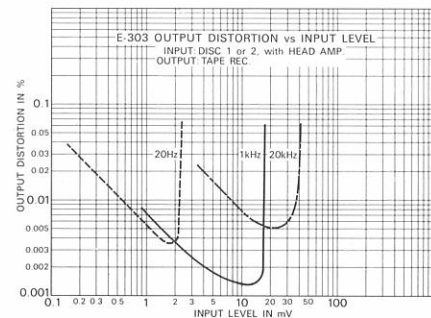
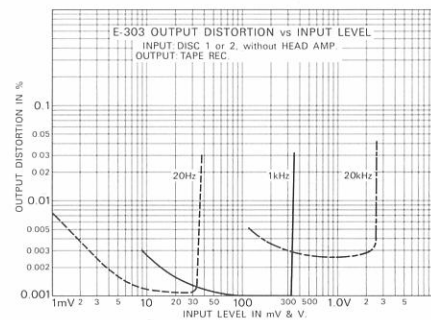
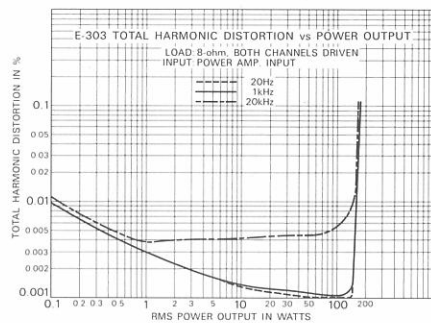
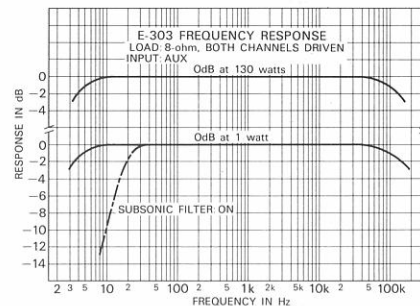

Accuphase
 ACCUPHASE LABORATORY INC.